



Product Model Number

CKO - M 8 1 8 - 1 2 0 0 2 0 - 1 0 0 1

✓ Model Number Definitions

CKO-XXXX-XXXXXX-XXXX



- A. Chun Kuang Optics Corp. Product
- B. Product Type: product abbreviation
Ex:
MX→Multi 33 in 1
SW→Single Wall Washer
CS→Soft Shading for CoB LED
HC→Holder for CoB LED

- C. Identity Code
- D. Lens / Fixture Size
Ex: 075026=Φ75mm / Thickness=26mm (round up)
- C. Serial Numbers

The lens datasheet is applicable for **Cree LED**, that manufactured by Chun Kuang Optics Corp.

✓ Dimensions (mm) : 120 x 19.9 x 8.7

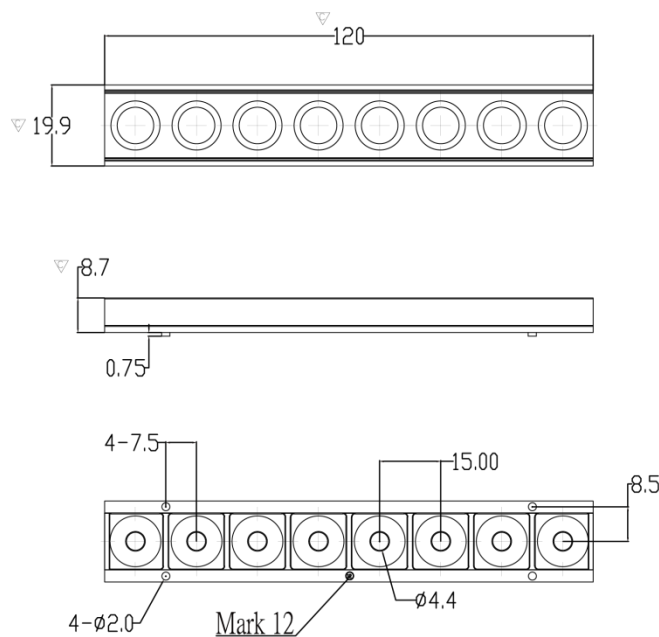



✓ **Optical Characteristics – Angle Performances**

Cree	LED LES (mm)	FWHM (degrees)	Field Angle (degrees)
XQ-E-HI	1.6 x 1.6	9°	23°
XT-E	3.45 x 3.45	17°	37°
XP-E2	3.5 x 3.5	12°	27°
XP-G2	3.5 x 3.5	17°	35°
XP-G3	3.5 x 3.5	20°	43°



Optical Characteristics

Model Number	CKO-M818-120020-1001	
LED	XQ-E-HI	
LES / LED Size	1.6 x 1.6 mm	
FWHM (D50)	9°	
Field Angle (D10)	23°	
Dimension	wxh =120 x 19.9 mm, Thickness=8.7 mm	
Luminous Flux	572 lm	Measured @ 7 W
Material	PC / UL94V2	

cd/klm

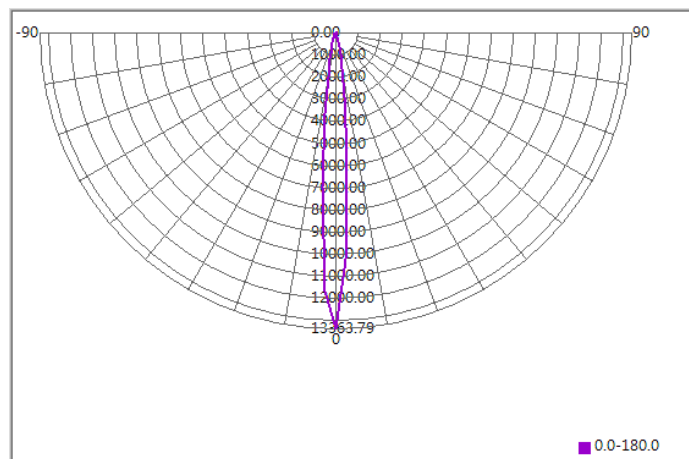

Illuminance At Distances

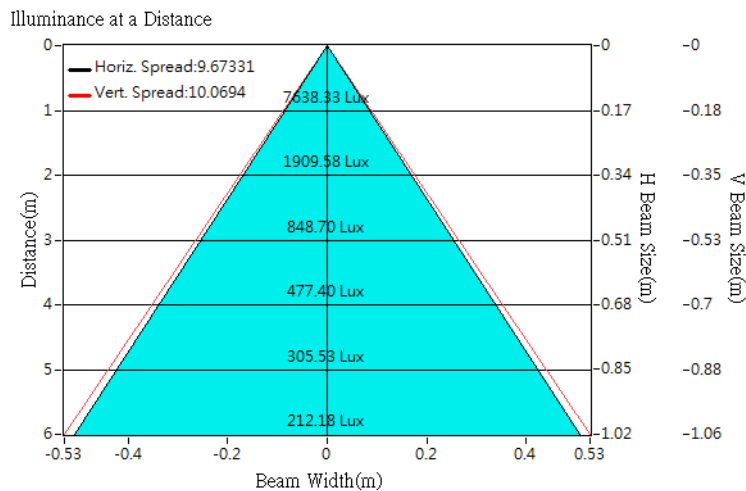



Optical Characteristics

Model Number	CKO-M818-120020-1001	
LED	XT-E	
LES / LED Size	3.45 x 3.45 mm	
FWHM (D50)	17°	
Field Angle (D10)	37°	
Dimension	wxh =120 x 19.9 mm, Thickness=8.7 mm	
Luminous Flux	393 lm	Measured @ 3.4 W
Material	PC / UL94V2	

cd/klm

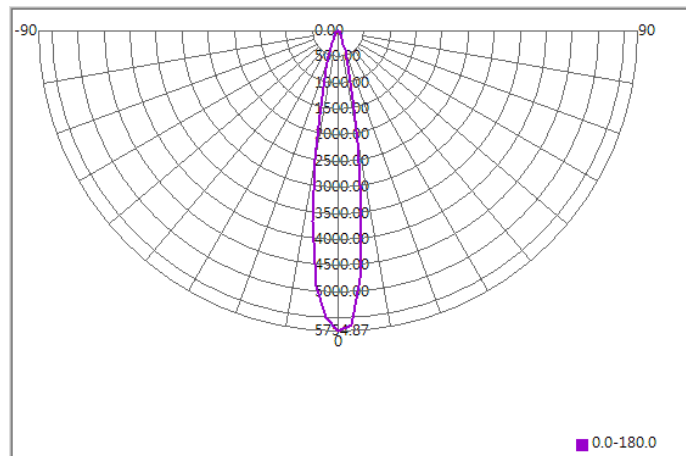

Illuminance At Distances

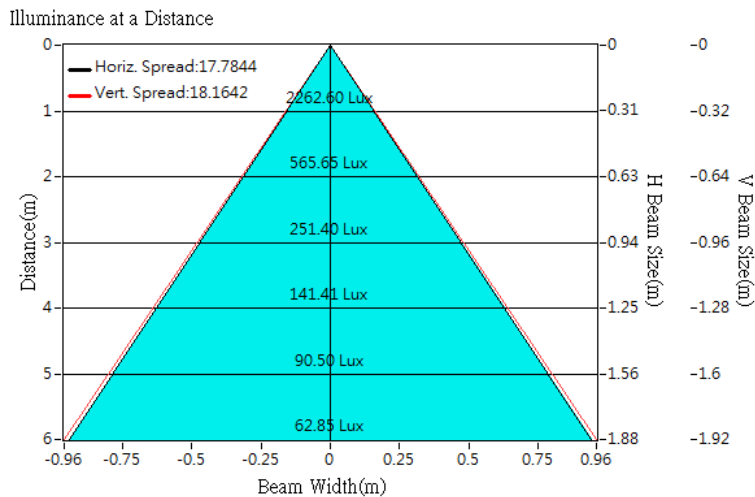



Optical Characteristics

Model Number	CKO-M818-120020-1001	
LED	XP-E2	
LES / LED Size	3.5 x 3.5 mm	
FWHM (D50)	12°	
Field Angle (D10)	27°	
Dimension	wxh =120 x 19.9 mm, Thickness=8.7 mm	
Luminous Flux	380 lm	Measured @ 3.5 W
Material	PC / UL94V2	

cd/klm

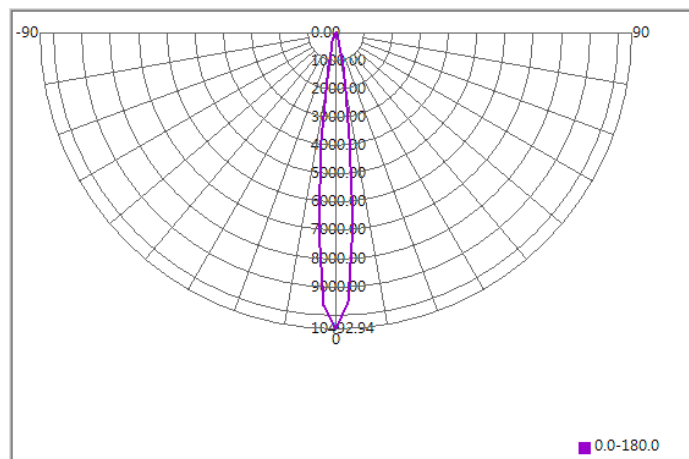

Illuminance At Distances

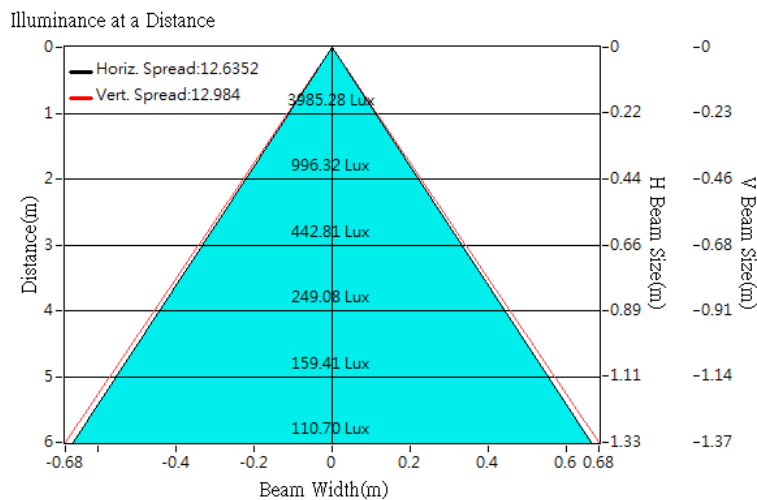



Optical Characteristics

Model Number	CKO-M818-120020-1001	
LED	XP-G2	
LES / LED Size	3.5 x 3.5 mm	
FWHM (D50)	17°	
Field Angle (D10)	35°	
Dimension	wxh =120 x 19.9 mm, Thickness=8.7 mm	
Luminous Flux	491 lm	Measured @ 3.3 W
Material	PC / UL94V2	

cd/klm

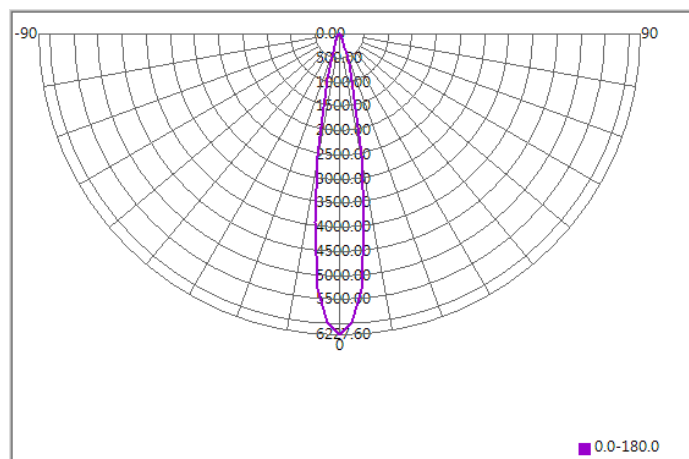

Illuminance At Distances

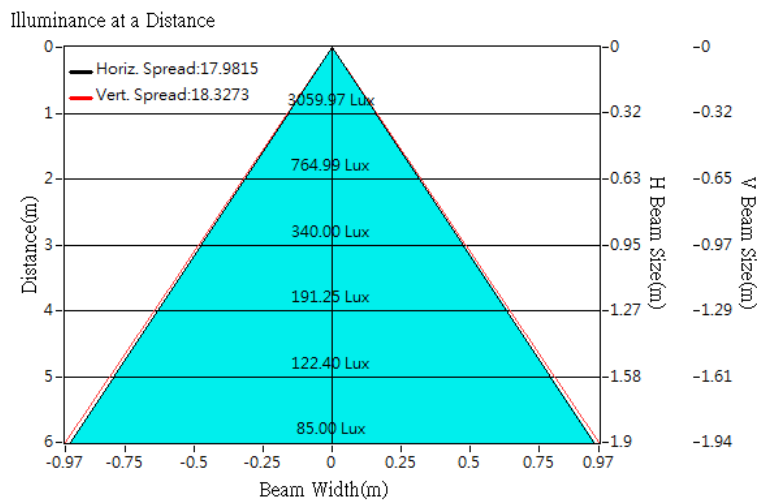



Optical Characteristics

Model Number	CKO-M818-120020-1001	
LED	XP-G3	
LES / LED Size	3.5 x 3.5 mm	
FWHM (D50)	20°	
Field Angle (D10)	43°	
Dimension	wxh =120 x 19.9 mm, Thickness=8.7 mm	
Luminous Flux	563 lm	Measured @ 3.3 W
Material	PC / UL94V2	

cd/klm

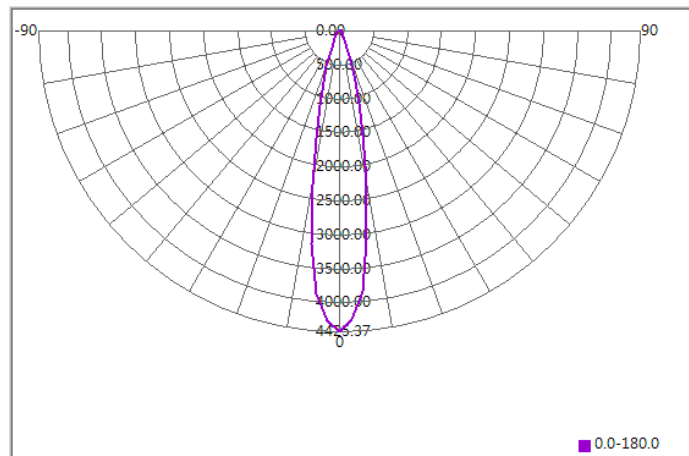

Illuminance At Distances

